

EXPLODED DRAWING A—Model No. F609.1

R0410A

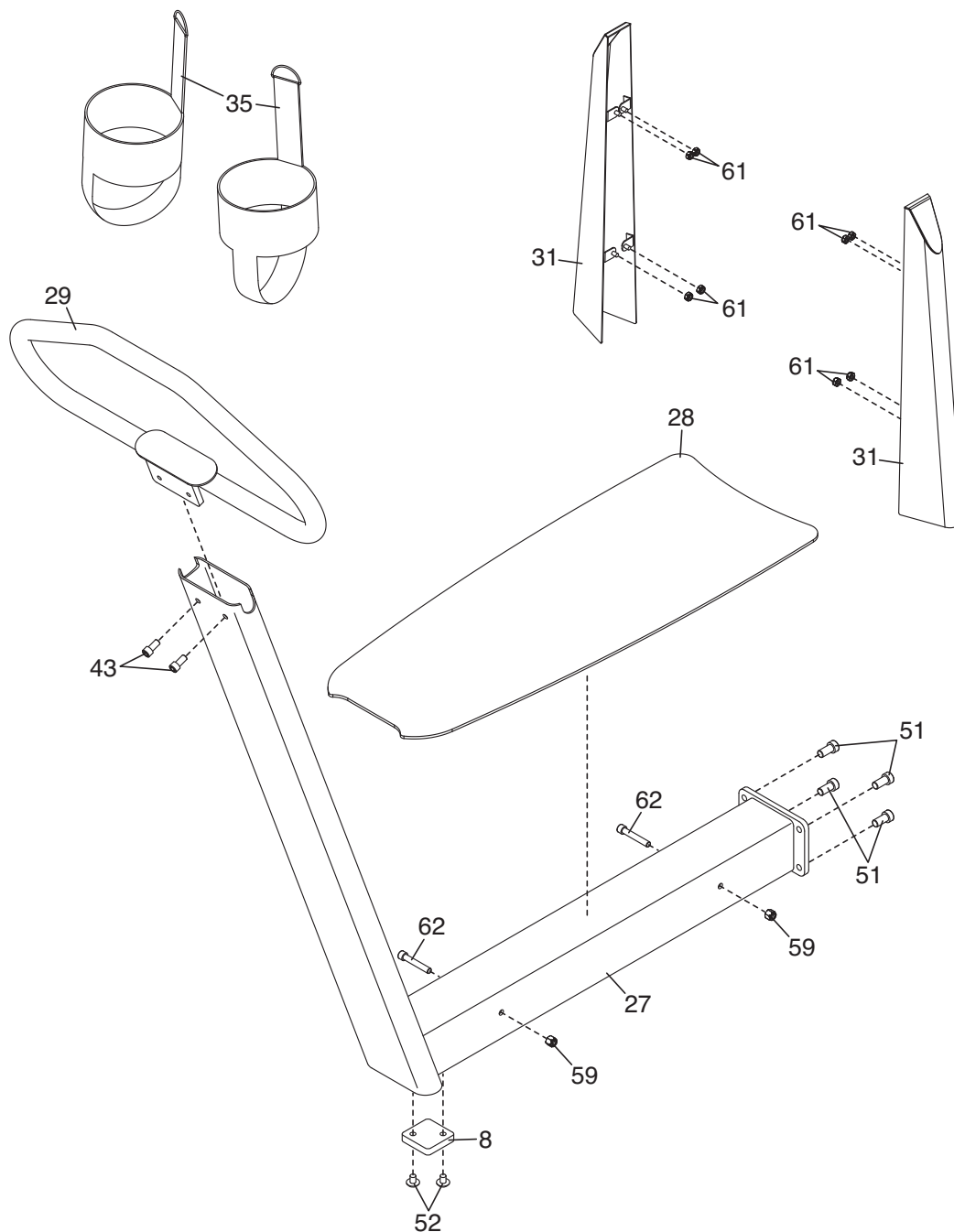

EXPLODED DRAWING B—Model No. F609.1

R0410A

